

Order Online



eSTORE
store.milacron.com

Available Online **24/7**



Or Call Our Customer Care Team

AT
P: 800 301 60
F: 800 401 020
dme_oesterreich@dme.net

DE
P: 800 664 82 50 | +49 (0) 2351 437 0
F: 800 664 82 51 | +49 (0) 2351 437 220
dme_normalien@dme.net

IT
P: 800 089 734
F: 800 089 735
dme_italy@dme.net

SK
P: 800 142 451 | +420 572 151 754
F: 800 142 450 | +420 571 611 996
dme_cz@dme.net

BE
P: +32 (0) 15 28 87 30
F: +32 (0) 15 40 51 17
dme_benelux@dme.net

ES
P: 900 900 342
F: 900 900 343
dme_iberia@dme.net

NL
P: +31 (0) 20 654 5571
F: +31 (0) 20 654 5572
dme_benelux@dme.net

UK
P: +44 2071 3300 37
F: +44 2071 3300 36
dme_uk@dme.net

CH
P: +41 0848 567 364
F: +41 0848 567 365
dme_schweiz@dme.net

FR
P: +33 1 49 93 92 23
F: +33 1 49 93 92 22
dme_france@dme.net

PL
P: +800 331 1312 | +32 15 21 50 92
F: +800 331 1313 | +32 15 40 51 92
dme_polska@dme.net

Other countries
P: +32 15 28 87 30
F: +32 15 40 51 17
dme_export@dme.net

CZ
P: 800 142 451 | +420 572 151 754
F: 800 142 450 | +420 571 611 996
dme_cz@dme.net

HU
P: 0680 205 003 | +32 15 28 87 30
F: +32 15 40 51 17
dme_hungary@dme.net

PT
P: 800 207 900
F: 800 207 901
dme_iberia@dme.net

eSTORE
store.milacron.com



HT

- High temperature
- Indexable
- Blind Hole
- Removable with one screw
- Stainless steel 50/55 HRC

HTIA HTYA

- Dedicated inserts for HT date stamps

page 2



U

- Blind Hole
- Indexable
- Stainless Steel 50/55 HRC

OOU YUU

- Dedicated inserts for U date stamps

page 3



U type S

- Blind Hole
- Fix it with one screw
- Indexable
- Stainless Steel 50/55 HRC

OOU YUU

- Dedicated inserts for U type S date stamps

page 4



O

- Indexable
- Removable with one screw
- Corrosion Resistant Steel 50/55 HRC

OANYAN OASYAS

- Dedicated inserts for O date stamps

page 5



F

- Indexable
- Blind hole
- Removable with one screw
- Corrosion resistant steel 50/55 HRC

OON YON OOS YOS

- Dedicated inserts for F date stamps

page 6



MD

- Multidater
- Blind Hole
- Double indexable
- Stainless Steel 50/55 HRC

page 7



IA SF-IA

- Inner inserts for FA SF / FA 12 / FA

page 8



- DSF - Distance washers for UYM UOM UOY UOD UOS UOB UOR
- SCR5 - set of 5 screwdrivers for date stamps removal

page 9

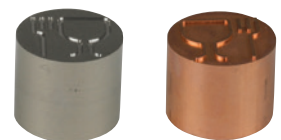

- MRI - recycling Insert
- MRE - recycling electrode

page 10

DATE STAMPS & INSERTS

HI TEMPERATURE INDEXABLE DATE STAMPS
HT

Mat.: Stainless Steel
 Hardness: 50-55 HRC
 Max. T: 340°C

Indexable
 Outer insert easily removable from the front with a screw.
 Remove inner insert from the outer insert using a screwdriver.
 Newly engineered inner insert is removed with less rotations due to shorter threads
 (not compatible with other DME inserts)
 Inner inserts use ball detents to click into position

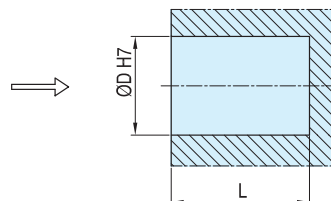
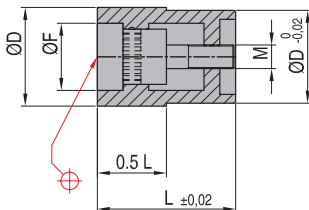
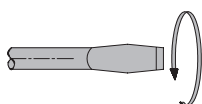

HTYM	HTOM	HTOY	HTOD	HTOS	HTOB	HTOR	*Specify year. Example: HTYM2104											
							REF*	REF	REF*	Number of years	REF	REF	REF	REF	D	F	L	M
							HTYM**04	HTOM0004	HTOY**04	6		HTOS0004	HTOB0004	HTOR0004	4	2,6	8	M1,8x0,35
							HTYM**06	HTOM0006	HTOY**06	6		HTOS0006	HTOB0006	HTOR0006	6	4	8	M2,5x0,4
							HTYM**08	HTOM0008	HTOY**08	6		HTOS0008	HTOB0008	HTOR0008	8	5	10	M3 x 0,5
							HTYM**10	HTOM0010	HTOY**10	6		HTOS0010	HTOB0010	HTOR0010	10	6,3	12	M3 x 0,5
							HTYM**12	HTOM0012	HTOY**12	6		HTOS0012	HTOB0012	HTOR0012	12	7,5	14	M4 x 0,7
							HTYM**16	HTOM0016	HTOY**16	6	HTOD0016	HTOS0016	HTOB0016	HTOR0016	16	11	14	M5 x 0,8
							HTYM**20	HTOM0020	HTOY**20	6	HTOD0020	HTOS0020	HTOB0020	HTOR0020	20	13,2	16	M5 x 0,8

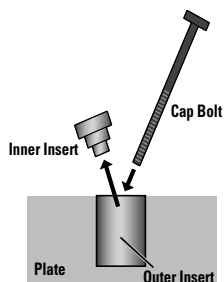
Quick removal procedure

Remove the inside insert.
 Insert cap bolt into outer insert hole.

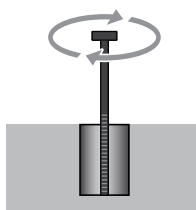

Turn the cap bolt clockwise into the outer inserts under threads.

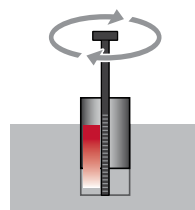

Continue turning the cap bolt clockwise raising the outer insert up from the plate.

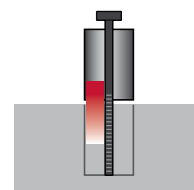

Remove the outer insert from the plate when it has cleared the hole.

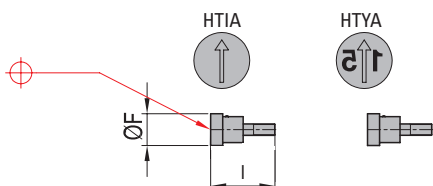
HI TEMPERATURE DATE STAMPS-INNER INSERTS
HT

Mat.: Stainless Steel
 Hardness: 50-55 HRC
 Max. T: 340°C

HTIA	HTYA	*Specify year. Example: HTYA2104	
		REF	REF*
		ØF	L
		HTIA0004	HTYA**04
		HTIA0006	HTYA**06
		HTIA0008	HTYA**08
		HTIA0010	HTYA**10
		HTIA0012	HTYA**12
		HTIA0016	HTYA**16
		HTIA0020	HTYA**20

INDEXABLE DATE STAMPS U



Mat.: Stainless steel
Hardness: 50-55 HRC
Max. T: 150°C

Remove inner insert from the outer insert using a screwdriver

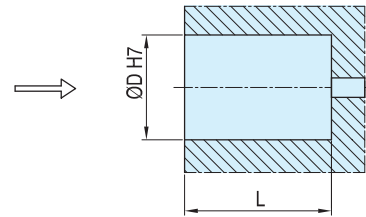
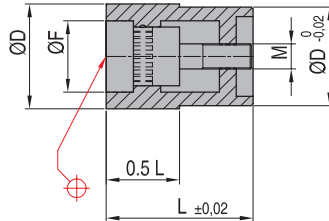
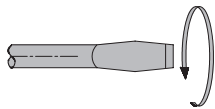

UYM	UOM	UOY	UOD	UOS	UOB	UOR	*Specify year. Example: UYM042021											
							REF*	REF	REF*	Number of years	REF	REF	REF	REF	D	L	F	M
							UYM0420**	UOM 04	UOY04/420**	4	UOD 16	UOS 04	UOB 04	UOR 04	4	8	2,4	M1,6x0,2
							UYM0520**	UOM 05	UOY05/420**	4	UOD 20	UOS 05	UOB 05	UOR 05	5	8	2,9	M1,6x0,2
							UYM0620**	UOM 06	UOY06/420**	4	UOD 20	UOS 06	UOB 06	UOR 06	6	8	3,7	M1,6x0,2
							UYM0820**	UOM 08	UOY08/420**	4	UOD 20	UOS 08	UOB 08	UOR 08	8	10	5,0	M2,3x0,25
							UYM1020**	UOM 10	UOY10/420**	4	UOD 20	UOS 10	UOB 10	UOR 10	10	12	6,3	M2,5x0,35
							UYM1220**	UOM 12	UOY12/420**	4	UOD 20	UOS 12	UOB 12	UOR 12	12	14	7,5	M3x0,35
							UYM1620**	UOM 16	UOY16/420**	4	UOD 20	UOS 16	UOB 16	UOR 16	16	14	11,0	M4x0,35
							UYM2020**	UOM 20	UOY20/420**	4	UOD 20	UOS 20	UOB 20	UOR 20	20	16	13,2	M4x0,35

DATE STAMPS-INNER INSERTS OUU-YUU

Mat.: Corrosion resistant steel
Hardness: 50-55 HRC

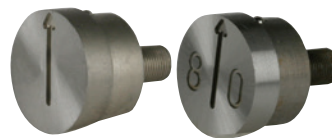
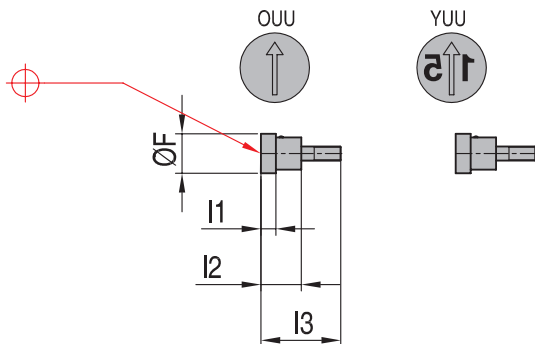

OUU	YUU	*Specify year. Example: YUU042021					
		REF	REF*	F	I1	I2	I3
		OUU 04	YUU0420**	2,4	1,5	4,5	7,7
		OUU 05	YUU0520**	2,9	1,5	4,5	7,7
		OUU 06	YUU0620**	3,7	1,5	4,5	7,7
		OUU 08	YUU0820**	5,0	2,0	5,5	9,7
		OUU 10	YUU1020**	6,3	2,5	6,5	11,7
		OUU 12	YUU1220**	7,5	2,5	6,8	13,7
		OUU 16	YUU1620**	11,0	2,5	6,8	13,7
		OUU 20	YUU2020**	13,2	3,5	8,5	15,7

CAD reference point

DATE STAMPS & INSERTS

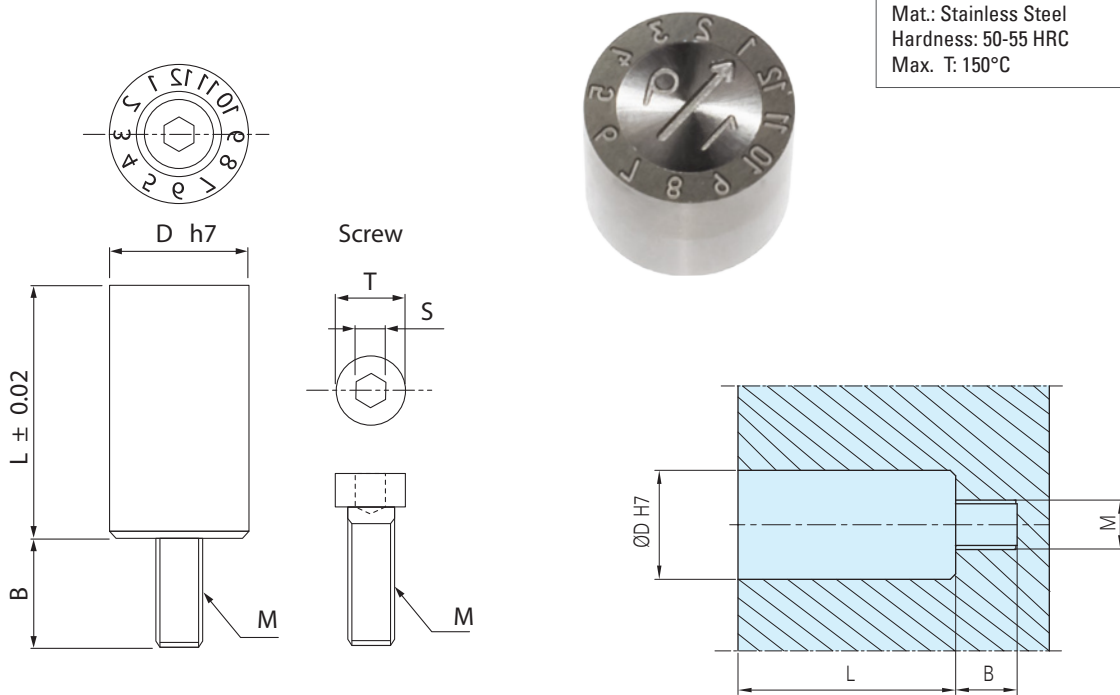
CORROSION RESISTANT INDEXABLE DATE STAMPS
U type S

Mat.: Stainless Steel
Hardness: 50-55 HRC
Max. T: 150°C

REF*	REF	REF*	Number of years	REF*	REF	REF	REF	D	L	B	T	S	M
UYM**06S	UOM0006S	UOY**06S	4	UOR0006S	UOS0006S	UOB0006S		6	11	4,7	3	1,27	M2x0,4
UYM**10S	UOM0010S	UOY**10S	4	UOR0010S	UOS0010S	UOB0010S		10	15	4,5	5	1,5	M3x0,5
UYM**16S	UOM0016S	UOY**16S	4	UOR0016S	UOS0016S	UOB0016S	UOD0016S	16	18	5,8	7,5	3	M5x0,8

*Specify year. Example: UYM2106S

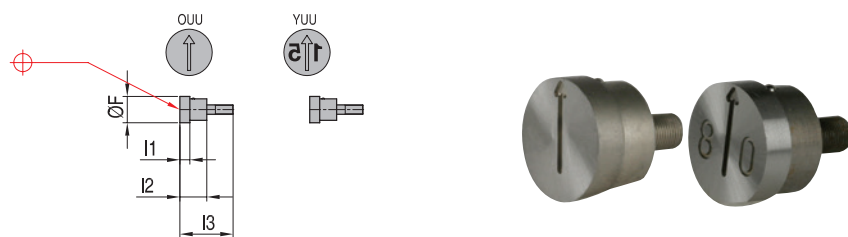
CORROSION RESISTANT INDEXABLE DATE STAMPS-INNER INSERTS
U type S

Mat.: Corrosion resistant steel
Hardness: 50-55 HRC

REF	REF*	F	l1	l2	l3
OUU 04	YUU0420**	2,4	1,5	4,5	7,7
OUU 05	YUU0520**	2,9	1,5	4,5	7,7
OUU 06	YUU0620**	3,7	1,5	4,5	7,7
OUU 08	YUU0820**	5,0	2,0	5,5	9,7
OUU 10	YUU1020**	6,3	2,5	6,5	11,7
OUU 12	YUU1220**	7,5	2,5	6,8	13,7
OUU 16	YUU1620**	11,0	2,5	6,8	13,7
OUU 20	YUU2020**	13,2	3,5	8,5	15,7

*Specify year. Example: YUU042021

CORROSION RESISTANT DATE STAMPS



Mat.: Corrosion resistant steel
 Hardness: 50-55 HRC
 Max. T: 150°C

Remove inner insert from the outer insert using a screwdriver

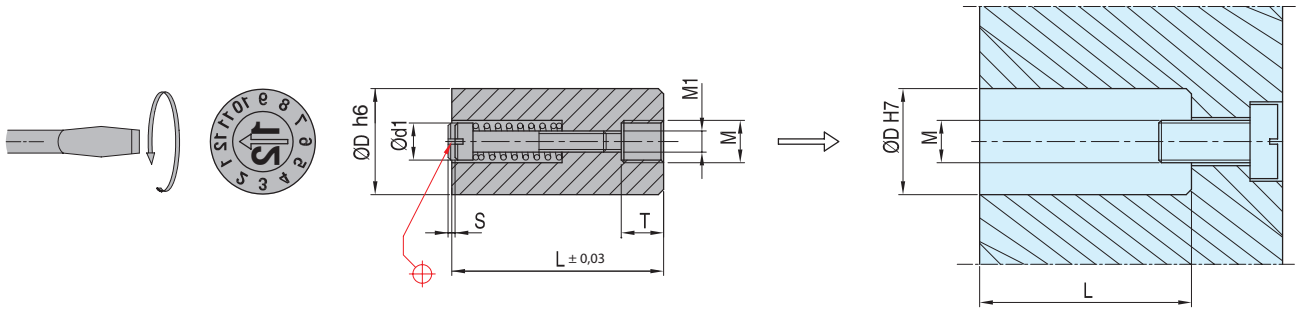

									*Specify year. Example: YMN052021					
		only year	year - week	only day	only shift									
REF	REF*	REF*	Number of years	REF*	REF	REF	REF	REF	REF	D	L	M	T	S
OMN04	YMN0420**	OYN0420**	6	YWN0420**	ODN 04	OSN 04	AMN 04	NZN 04	OBN 04	4	14	M2	2	0,2
OMN 05	YMN0520**	OYN0520**	6	YWN0520**	ODN 05	OSN 05	AMN 05	NZN 05	OBN 05	5	17	M3	3,5	0,20
OMN 06	YMN0620**	OYN0620**	6	YWN0620**	ODN 06	OSN 06	AMN 06	NZN 06	OBN 06	6	17	M3	3,5	0,20
OMN 08	YMN0820**	OYN0820**	6	YWN0820**	ODN 08	OSN 08	AMN 08	NZN 08	OBN 08	8	20	M4	4,0	0,35
OMN 10	YMN1020**	OYN1020**	6	YWN1020**	ODN 10	OSN 10	AMN 10	NZN 10	OBN 10	10	20	M5	4,0	0,35
OMN 12	YMN1220**	OYN1220**	6	YWN1220**	ODN 12	OSN 12	AMN 12	NZN 12	OBN 12	12	25	M6	6,0	0,50
OMN 16	YMN1620**	OYN1620**	6	YWN1620**	ODN 16	OSN 16	AMN 16	NZN 16	OBN 16	16	33	M8	8,0	0,60
OMN 20	YMN2020**	OYN2020**	6	YWN2020**	ODN 20	OSN 20	AMN 20	NZN 20	OBN 20	20	33	M8	8,0	0,60



Special engraving available upon request

OAN-YAN-OAS-YAS

Mat.: Corrosion resistant steel
 Hardness: 50-55 HRC
 Max. T:150

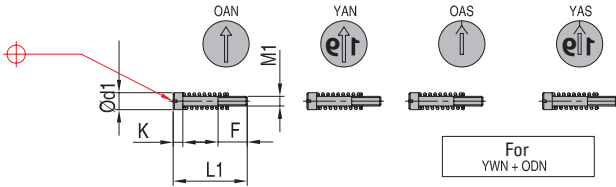

				*Specify year. Example: YAN052021				
		OAS: for ODN	YAS: for YWN					
REF	REF*	REF	REF*	M1	d1	K	F	L1
OAN04	YAN0420**	OAS 04	YAS0420**	M1,4 x 0,2	2,5	2,3	4	10,5
OAN 05	YAN0520**	OAS 05	YAS0520**	M1,6 x 0,2	3,1	3	5	13
OAN 06	YAN0620**	OAS 06	YAS0620**	M1,6 x 0,2	3,1	3	5	13
OAN 08	YAN0820**	OAS 08	YAS0820**	M2,5 x 0,35	4,6	4	6	14
OAN 10	YAN1020**	OAS 10	YAS1020**	M2,5 x 0,35	4,6	4	6	14
OAN 12	YAN1220**	OAS 12	YAS1220**	M3 x 0,50	6,4	4	6	17
OAN 16	YAN1620**	OAS 16	YAS1620**	M3,5 x 0,60	8,4	5	8	23
OAN 20	YAN2020**	OAS 20	YAS2020**	M3,5 x 0,60	11,0	5	8	23

CAD reference point

DATE STAMPS & INSERTS

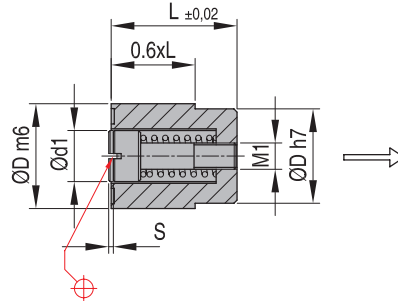
DATE STAMPS
F

Mat.: Corrosion resistant steel
 Hardness: 50-55 HRC
 Max. T: 150°C

Remove inner insert from the outer insert using a screwdriver

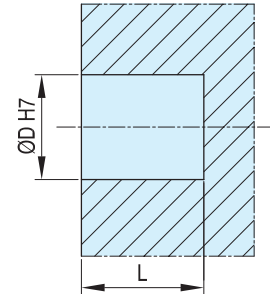

REF	REF*	REF*	Y	REF*	Y	REF*	REF	REF	REF	REF	REF	D	L	S	M1
FOM	FYM	FOY		FYW	FOD	FOS	FAM	FNZ	FOB	*Specify year. Example: FYM00032021					
only month	year - month	only year		year - week	only day	only shift	A → M	N → Z	only blank						
FOM0002-6	FYM0002-620**			FOY0002-620**	6		FOS0002-6	FAM0002-6	FNZ0002-6	FOB0002-6	2,6	4	0,2	M0,8 x 0,2	
FOM0003	FYM000320**	FOY7032021	7	FOY0003-20	6		FOS0003	FAM0003	FNZ0003	FOB0003	3	4	0,2	M0,8 x 0,2	
FOM0004	FYM000420**	FOY7042021	7	FOY0004-20	6		FOS0004	FAM0004	FNZ0004	FOB0004	4	5	0,2	M1,1 x 0,25	
FOM0005	FYM000520**	FOY7052021	7	FOY0005-20	6	FYW000520**	FOD0005	FOS0005	FAM0005	FNZ0005	FOB0005	5	8	0,2	M1,6 x 0,2
FOM0006	FYM000620**	FOY7062021	7	FOY0006-20	6	FYW000620**	FOD0006	FOS0006	FAM0006	FNZ0006	FOB0006	6	8	0,2	M1,6 x 0,2
FOM0008	FYM000820**	FOY7082021	7	FOY0008-20	6	FYW000820**	FOD0008	FOS0008	FAM0008	FNZ0008	FOB0008	8	10	0,25	M2,3 x 0,25
FOM0010	FYM001020**	FOY7102021	7	FOY0010-20	6	FYW001020**	FOD0010	FOS0010	FAM0010	FNZ0010	FOB0010	10	12	0,35	M2,5 x 0,35
FOM0012	FYM001220**	FOY7122021	7	FOY0012-20	6	FYW001220**	FOD0012	FOS0012	FAM0012	FNZ0012	FOB0012	12	14	0,35	M3 x 0,35
FOM0016	FYM001620**	FOY7162021	7	FOY0016-20	6	FYW001620**	FOD0016	FOS0016	FAM0016	FNZ0016	FOB0016	16	14	0,35	M4 x 0,35
FOM0020	FYM002020**	FOY7202021	7	FOY0020-20	6	FYW002020**	FOD0020	FOS0020	FAM0020	FNZ0020	FOB0020	20	16	0,35	M4 x 0,35



Special engraving available upon request

Y - Number of years

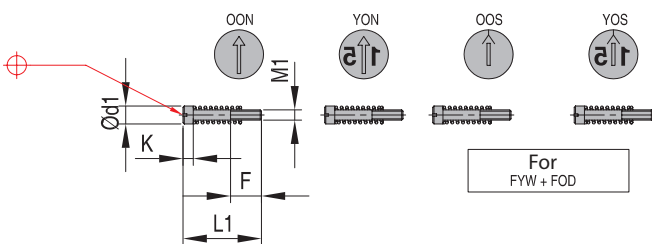
DATE STAMPS-INNER INSERTS
OON-YON-OOS-YOS

Mat.: Corrosion resistant steel
 Hardness: 50-55 HRC



REF	REF*	REF	REF*	M1	d1	K	F	L1
OON2-6	YON02-620**			M0,8 x 0,2	1,4	0,9	1,5	4
OON3	YON0320**			M0,8 x 0,2	1,5	0,9	1,5	4
OON4	YON0420**			M1,1 x 0,25	2,1	1,2	2,0	5
OON5	YON0520**	OOS5	YOS0520*	M1,6 x 0,2	3,1	2,0	3,0	8
OON6	YON0620**	OOS6	YOS0620*	M1,6 x 0,2	3,1	2,0	3,0	8
OON8	YON0820**	OOS8	YOS0820*	M2,3 x 0,25	4,4	2,5	4,0	10
OON10	YON1020**	OOS10	YOS1020*	M2,5 x 0,35	5,2	3,0	4,5	12
OON12	YON1220**	OOS12	YOS1220*	M3 x 0,35	6,2	3,0	5,0	14
OON16	YON1620**	OOS16	YOS1620*	M4 x 0,35	8,2	3,5	5,0	14
OON20	YON2020**	OOS20	YOS2020*	M4 x 0,35	11	4,5	5,0	16

*Specify year. Example: YON032021

OOS: for FOD

YOS: for FYW

MULTIDATER

MD



Mat.: Stainless steel
 Hardness: 50-55 HRC
 Max. T: 150°C

Outer ring: 12 months, months 1 through 12
 Inner ring: 6 years + arrow (arrow points to month)
 Center insert: arrow (points to year & adjusts position of both arrows)
 Double indexable: both arrows independently "click into position"
 Change positions easily with only a screwdriver using arrow in inner insert
 Turn clockwise to change "year" arrow (6 years)
 Turn counter-clockwise to change "month" arrow (12 months)
 All inserts remain flush when rotated
 Dual-Ring Insert may be interchanged for the 20mm, 16mm, 10mm, 8mm to 6mm diameter Indexable and Front Removable inserts

The MDxxOD version is needed to trace days. The inner ring counts the ten and the outer ring counts the units.
 The two Multidaters together indicate a complete date. For example 31 on the MDxxOD version and 10 2019 on the other; indicating 31st of October 2019.

REF	REF*	Number of years	D	d1	d2	L	L/2
MD06OD	MD0620*	6	6	3,8	1,8	10	5
MD08OD	MD0820*	6	8	5,3	2,5	10	5
MD10OD	MD1020*	6	10	6,4	3,2	12	6
MD16OD	MD1620*	6	16	10,5	5,0	14	7

*Specify year. Example: MD062021

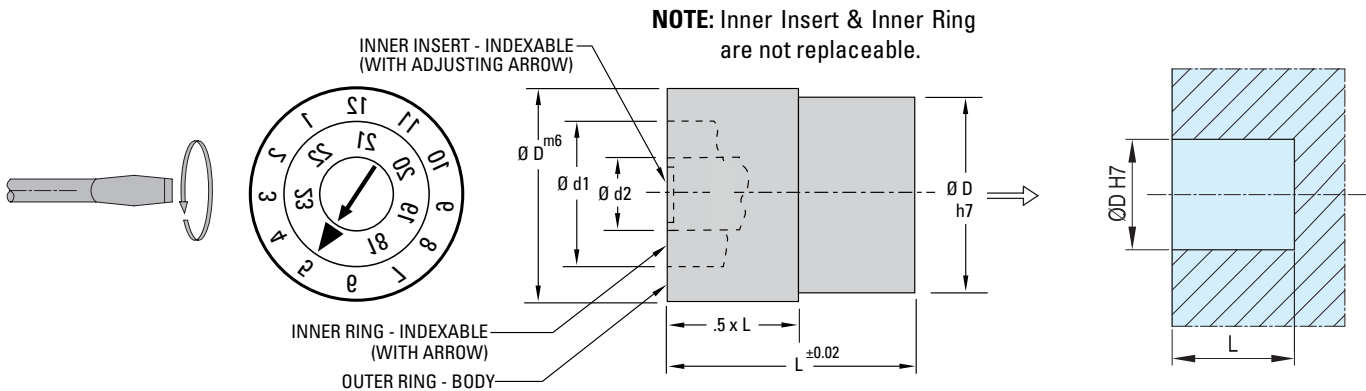

Installation and Machining

- Press-fit installation required
- Maintain a close tolerance press fit. Too loose a fit could allow the insert to move out of position, while too tight a press fit might prevent the inner insert and inner ring from rotating when required
- Accurately measure the Ø D for each part and machine hole to provide about 0.005mm (.0002") press fit

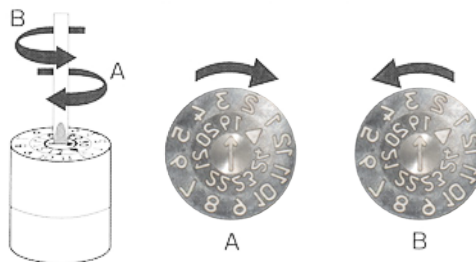

Structure and Usage

- Method of changing over the indication
- Changing the year indication. When the center part is turned clockwise (A), only the inside arrow rotates, enables the year to be changed.
- Changing the month indication. Turning the center part counterclockwise (B) causes both the inside arrow and the second ring to turn simultaneously, enabling the month to be changed.

DATE STAMPS & INSERTS

INNER INSERTS FOR FA SF - FA 12 - FA
IA SF - IA

Mat.: Stainless steel
 Hardness: 50-55 HRC
 Max. T:150°

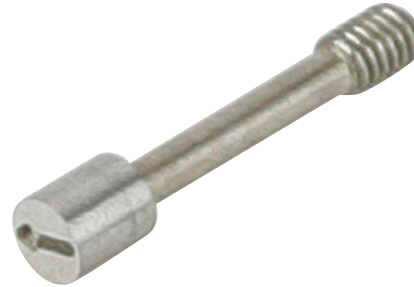
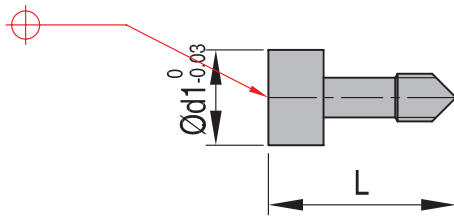

REF*	d1	L
IA321720*	3,2	17,0
IA471720*	4,7	17,0
IA571720*	5,7	17,0
IA671720*	6,7	17,0
IA871720*	8,7	17,0
IA100720*	10,7	17,0
IA227520*	2,2	7,5
IA307520*	3,0	7,5

*Specify year. Example: IA32172021

DISTANCE WASHERS FOR UYM, UOM, UOY, UOD, UOS, UOB, UOR **DSF**

Mat.: Corrosion resistant steel
Hardness: 50-55 HRC

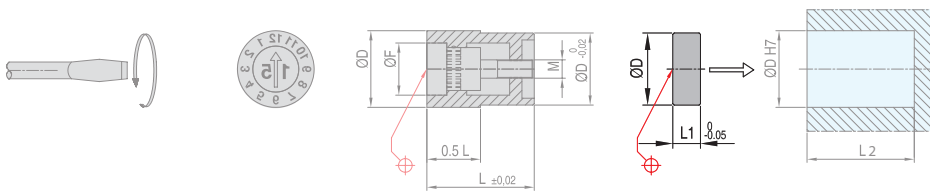

													*Specify year. Example: DSFUYM2104												
													UYM	UOM	UOY	UOD	UOS	UOB	UOR						
REF	L1	L2	REF*	REF	REF*	REF*	REF	REF	REF	D	L	F	M												
DSF 0404	4	12	UYM0420**	UOM 04	UOY0420**		UOS 04	UOB 04	UOR 04	4	8	2,4	M1,6x0,2												
DSF 0504	4	12	UYM0520**	UOM 05	UOY0520**		UOS 05	UOB 05	UOR 05	5	8	2,9	M1,6x0,2												
DSF 0612	12	20	UYM0620**	UOM 06	UOY0620**		UOS 06	UOB 06	UOR 06	6	8	3,7	M1,6x0,2												
DSF 0810	10	20	UYM0820**	UOM 08	UOY0820**		UOS 08	UOB 08	UOR 08	8	10	5,0	M2,3x0,25												
DSF 1008	8	20	UYM1020**	UOM 10	UOY1020**		UOS 10	UOB 10	UOR 10	10	12	6,3	M2,5x0,35												
DSF 1206	6	20	UYM1220**	UOM 12	UOY1220**		UOS 12	UOB 12	UOR 12	12	14	7,5	M3x0,35												
DSF 1606	6	20	UYM1620**	UOM 16	UOY1620**	UOD 16	UOS 16	UOB 16	UOR 16	16	14	11,0	M4x0,35												
DSF 2004	4	20	UYM2020**	UOM 20	UOY2020**	UOD 20	UOS 20	UOB 20	UOR 20	20	16	13,2	M4x0,35												

SCREWDRIVER SET **SCR 5**



- Set of 5 screw drivers
- Custom made for the complete DME range of date stamps
- Blades made of chrome-vanadium-molybdenum-steel fully hardened and chromium plated for precision and long life
- Ergonomic handle design
- Color coded pivot cap
- Extremely precise fit of the tip

			UYM	FYM	YMN	MD
2x	1,1 x 0,20 x 60			Ø2,6 Ø3		
1x	1,6 x 0,15 x 60		Ø4	Ø4	Ø4	
1x	2,3 x 0,20 x 60		Ø5 Ø6	Ø5 Ø6	Ø5 Ø6	Ø10
1x	3,0 x 0,30 x 60		Ø8	Ø8	Ø8	Ø16

RECYCLING ELECTRODES & INSERTS

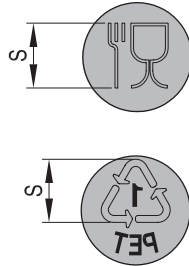
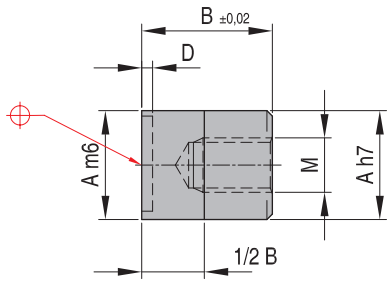
RECYCLING INSERTS
MRI

Mat.: Stainless steel 48-52 HRC

With these special inserts and electrodes plastic parts can be marked with useful information during the production process, usage and recycling process, e.g. with data on composition, recycling and purification.

	REF	A	B	D	M	S	Identification	
	MRI0100	10	12	0,3	M5	6	Arrows only	
	MRI0200	16	14		M6	10		
	MRI0300	20	16		M6	12		
	MRI1101 not hardened	10	12	0,3	M5	6	Blank	
	MRI2202 not hardened	16	14		M6	10		
	MRI3303 not hardened	20	16		M6	12		
	MRI0101GE	10	12	0,3	M5	6	Polyethylene terephthalate	PET
	MRI0201GE	16	14		M6	10		
	MRI0301GE	20	16		M6	12		
	MRI0101	10	12	0,3	M5	6	Polyethylene terephthalate	PETE
	MRI0201	16	14		M6	10		
	MRI0102	10	12	0,3	M5	6	High density polyethylene	HDPE
	MRI0202	16	14		M6	10		
	MRI0302	20	16		M6	12		
	MRI0102GE	10	12	0,3	M5	6	High density polyethylene	PE-HD
	MRI0202GE	16	14		M6	10		
	MRI0302GE	20	16		M6	12		
	MRI0103GE	10	12	0,3	M5	6	Polyvinyl chloride	PVC
	MRI0203GE	16	14		M6	10		
	MRI0303GE	20	16		M6	12		
	MRI0104	10	12	0,3	M5	6	Low density polyethylene	LDPE
	MRI0204	16	14		M6	10		
	MRI0304	20	16		M6	12		
	MRI0104GE	10	12	0,3	M5	6	Low density polyethylene	PE-LD
	MRI0204GE	16	14		M6	10		
	MRI0304GE	20	16		M6	12		
	MRI0104FR	10	12	0,3	M5	6	Low density polyethylene	PE-BD
	MRI0204FR	16	14		M6	10		
	MRI0304FR	20	16		M6	12		
	MRI0105	10	12	0,3	M5	6	Polypropylene	PP
	MRI0205	16	14		M6	10		
	MRI0305	20	16		M6	12		
	MRI0106	10	12	0,3	M5	6	Polystyrene	PS
	MRI0206	16	14		M6	10		
	MRI0306	20	16		M6	12		
	MRI0107	10	12	0,3	M5	6	All other resins	Other
	MRI0207	16	14		M6	10		
	MRI0307	20	16		M6	12		
	MRI0107GE	10	12	0,3	M5	6	All other resins	0
	MRI0207GE	16	14		M6	10		
	MRI0307GE	20	16		M6	12		
	MRI1010	10	12	0,3	M5	6,15	Food	
	MRI1016	16	14		M6	9,83		
	MRI1020	20	16		M6	12,3		

CAD reference point

RECYCLING ELECTRODES **MRE**

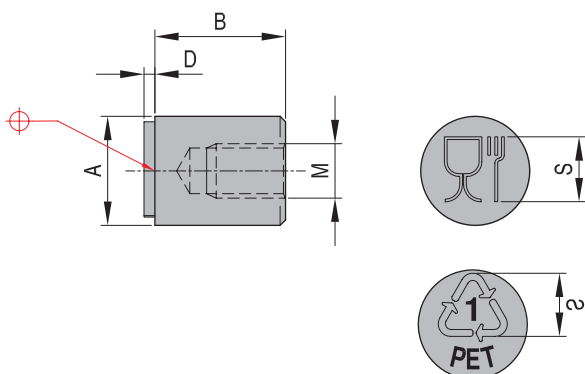

Mat.: Electrolytic copper E-Cu

With these special inserts and electrodes plastic parts can be marked with useful information during the production process, usage and recycling process, e.g. with data on composition, recycling and purification.

	REF	A	B	D	M	S	Identification	
	MRE-0100	10	12	0,3	M5	6	Arrows only	
	MRE-0200	16	14		M6	10		
	MRE-0300	20	16		M6	12		
	MRE-0101GE	10	12	0,3	M5	6	Polyethylene terephthalate	PET
	MRE-0201GE	16	14		M6	10		
	MRE-0301GE	20	16		M6	12		
	MRE-0102	10	12	0,3	M5	6	High density polyethylene	HDPE
	MRE-0202	16	14		M6	10		
	MRE-0302	20	16		M6	12		
	MRE-0102GE	10	12	0,3	M5	6	High density polyethylene	PE-HD
	MRE-0202GE	16	14		M6	10		
	MRE-0302GE	20	16		M6	12		
	MRE-0103GE	10	12	0,3	M5	6	Polyvinyl chloride	PVC
	MRE-0203GE	16	14		M6	10		
	MRE-0303GE	20	16		M6	12		
	MRE-0104	10	12	0,3	M5	6	Low density polyethylene	LDPE
	MRE-0204	16	14		M6	10		
	MRE-0304	20	16		M6	12		
	MRE-0104GE	10	12	0,3	M5	6	Low density polyethylene	PE-LD
	MRE-0204GE	16	14		M6	10		
	MRE-0304GE	20	16		M6	12		
	MRE-0104FR	10	12	0,3	M5	6	Low density polyethylene	PE-BD
	MRE-0204FR	16	14		M6	10		
	MRE-0304FR	20	16		M6	12		
	MRE-0105	10	12	0,3	M5	6	Polypropylene	PP
	MRE-0205	16	14		M6	10		
	MRE-0305	20	16		M6	12		
	MRE-0106	10	12	0,3	M5	6	Polystyrene	PS
	MRE-0206	16	14		M6	10		
	MRE-0306	20	16		M6	12		
	MRE-0107	10	12	0,3	M5	6	All other resins	Other
	MRE-0207	16	14		M6	10		
	MRE-0307	20	16		M6	12		
	MRE-0107GE	10	12	0,3	M5	6	All other resins	0
	MRE-0207GE	16	14		M6	10		
	MRE-0307GE	20	16		M6	12		
	MRE-01010	10	12	0,3	M5	6,15	Food	
	MRE-01016	16	14		M6	9,83		
	MRE-01020	20	16		M6	12,3		

CAD reference point





eSTORE
store.milacron.com
Available Online
24/7

MOULD
EJECTION

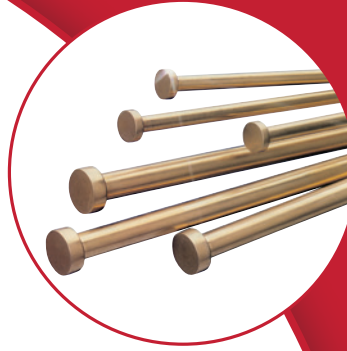

MOULD
COMPONENTS



PRE-ENGINEERED
COMPONENTS



MOULD
COOLING



TOOLS &
AUXILIARIES



Schaliënhoevedreef 20-D
(Mechelen Campus)
Mechelen | BE-2800 | Belgium
dme_uk@dme.net
+44 2071 3300 37

